

Integra32 CD Folder Contents

Server : Installs Server and Client 1 PC only (Setup.exe)
Communications Modules : Drivers and utilities (LIF-200, etc.)
Documents : All manuals in PDF format
Client : Installs Client (Setup.exe)
Firmware: Various firmware files
Update: Service packs
 Additional folders may appear on your CD:
 License, Web, DVR, Fingerprint, Etc.
 Adobe Acrobat Reader Included on CD



SERVER : PC Requirements

Processor : Intel Core 2 Duo or better
Memory : 1-2 GB depending on OS
Storage: 20 GB, or more is needed
CD-ROM, Ethernet Port, USB ports
Operating System : Windows
Editions : Pro, Business, Ultimate
32 Bit: XP SP3, Vista, 7
 Server 2003, 2008
64 Bit: 7, Server 2008

CLIENT : PC requirements

Processor : Intel Core 2 Duo or better
Memory : 1-2GB depending on OS
Storage: 5 GB, or more is needed
CD-ROM, Ethernet Port, 20 GB
Operating System : Windows
Editions : Pro, Business, Ultimate
32 Bit: XP SP3, Vista, 7; **64 Bit**: 7

OVERVIEW

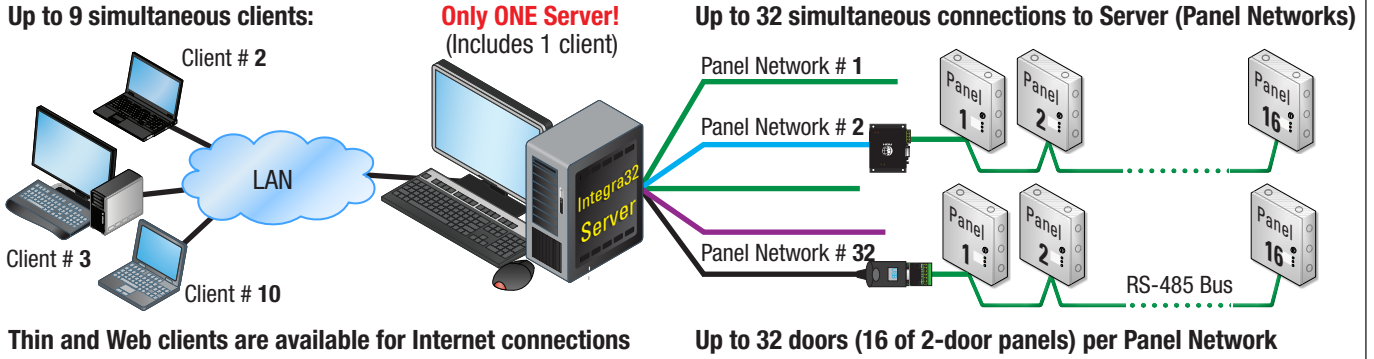

RS-232 : Serial Port to IRC-2000

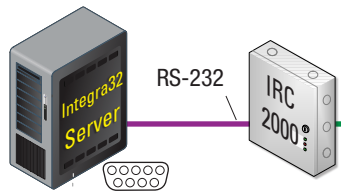

Up to 50' Max @ 9.6K to IRC-2000 only
 18-22 AWG 3-4 Cond. Shielded

RS-485 : USB to IRC-2000

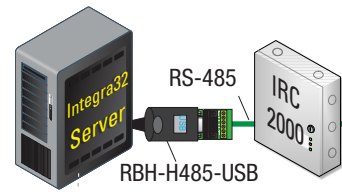

Up to 4,000' Max from PC to last Panel
 18-22 AWG 2-Cond. Shielded, Twisted

RBH-H485-USB : Installation

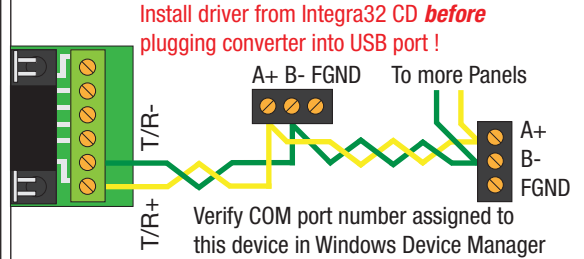

LIF-200 : Installation

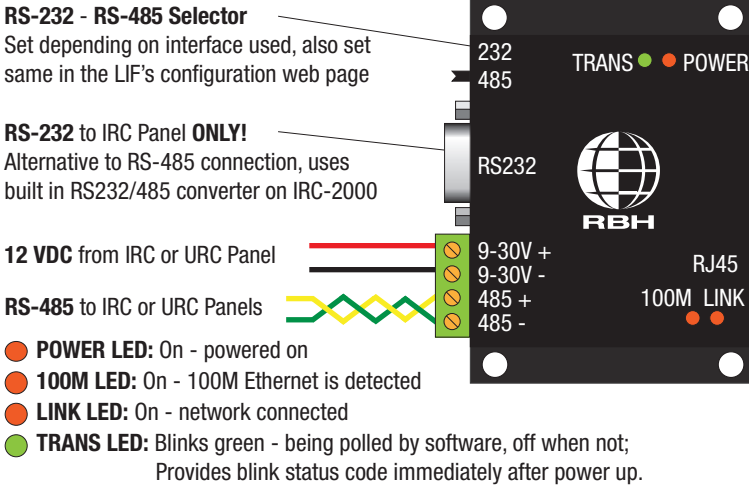

Refer to LIF-200 manual for default password and reset procedures
Default IP address : 192.168.125.125 **Default IP port** : 3002

ETHERNET LAN : PC to Network to LIF-200 to IRC-2000

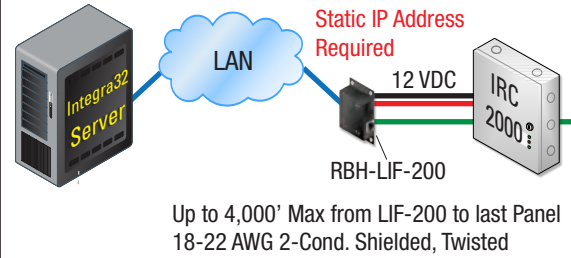

- A. LIF-200 and PC are on the same subnet:**
 LIF : XXX.XXX.ZZZ.AAA PC : XXX.XXX.ZZZ.BBB
 To configure LIF-200 type in it's address into web browser.
- B. LIF -200 and PC are on the same net, different subnets:**
 LIF : XXX.XXX.ZZZ.AAA PC : XXX.XXX.YYY.BBB
 Use IPLocator to detect LIF-200 and change it's IP address, go to **A**
- C. LIF-200 and PC are on different nets and/or subnets:**
 Manually set your PCs IP address to match net/subnet of the LIF-200, go to **A** to configure LIF-200

INTERNET : PC to Router to Internet to Router to LIF-200 to IRC-2000

RBH does not provide tech support on port forwarding!

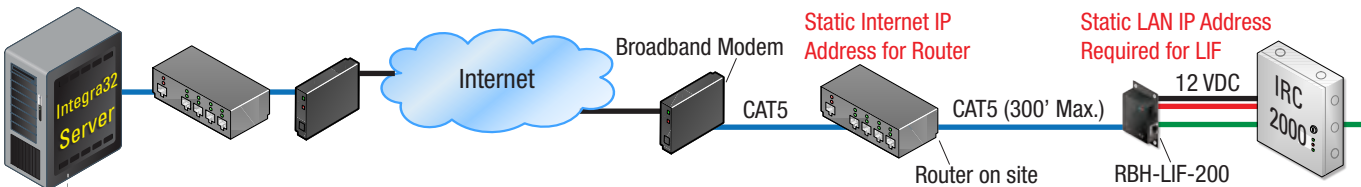

Port Forwarding - Configure Router to forward designated IP port on Internet IP address (as entered in Integra32) to a port on Local Network (LIF-200).
 Example: In Integra32 software set 5.6.23.7 port 75. On remote router forward remote site port 75 on 5.6.23.7 to LIF-200 on port 3002 on 192.168.1.125

TIP: Use Windows built-in Telnet client to test communications with LIF-200 (you may need to enable it first in Windows Vista, 7)
 This test verifies possibility of a successful connection from Integra32 Server PC to LIF-200: it checks if IP address exists and whether LIF is using right port
 Example: at command prompt on Integra32 Server PC type in: telnet <LIF-200 IP address> <IP port to use> (c:\telnet 192.168.1.125 3002) hit "Enter".
 If all is OK you will see blank screen with blinking cursor and "Trans" light on LIF will light up, if this does not happen contact IT staff for troubleshooting.

ACCESS POINT : Configuration

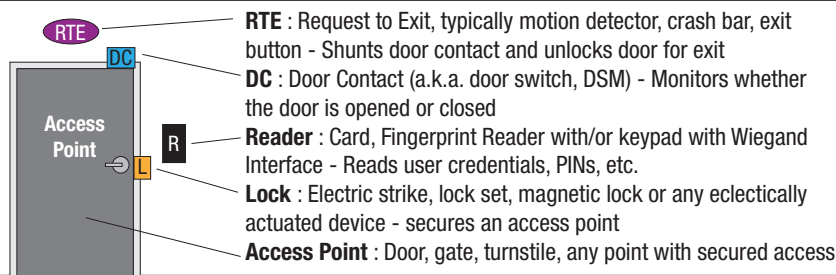

RTE Installed	DC Installed	Lock by timer	Lock on door close	Door Forced	Door Held Open
Yes	Yes	Yes	Yes	Yes	Yes
No	Yes	Yes	Yes	No*	Yes
No	No	Yes	No	No	No

* Will activate every time door is opened to exit, you can turn "Disable Door Forced Open" feature on

OUTPUTS:

Relay Outputs (Marked ?N.O./?N.C./?C): Maximum rating 5A @ 30V, Dry, Form "C" relay

Voltage Outputs (Marked ?OC): 100mA, -12VDC, for solid state devices only (LED, Piezo, etc.)

"ON State" Setting	Operation Type	"Output Off" Relay is:	"Output On" Relay is:	N.O. Mark	N.C. Mark
Energized	Fail-Secure	Off	On	N.O.	N.C.
De-energized	Fail-Safe	On	Off	N.C.*	N.O.*

* Functionality of relay polls will be reversed vs. printed marking

INSTALL DIODE on DC powered locks!
1N4004 Diode installed at the lock will prevent damage to the controller. Please, use MOVs (metal oxide varistors) for AC powered locks.

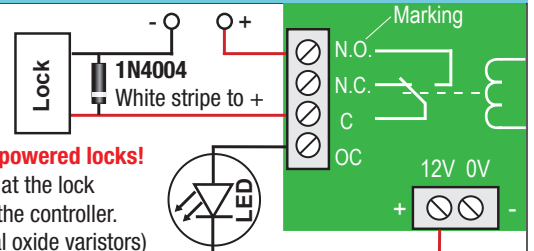

NO RELAYS OR LOCKS! on OC outputs

INPUTS:

Circuit Type	Normally Closed	Normally Open	N. C. 1 Resistor	N. O. 1 Resistor	N. C. 2 Resistors	N. O. 2 Resistors	N. C. & N.O. 1 Resistor
Open	Alarm	Restore	Alarm	Trouble	Trouble	Trouble	Trouble
Short	Restore	Alarm	Trouble	Alarm	Trouble	Trouble	Alarm
1K	N/A	N/A	Restore	Restore	Restore	Alarm	Restore
2K	N/A	N/A	N/A	N/A	Alarm	Restore	N/A
Circuit State							

Supervision type	Detects state changes:	Supervised secure	Supervised in alarm
None	Yes	No	No.
1 Resistor	Yes	Yes	No
2 Resistor	Yes	Yes	Yes

= **1K Resistor** Color code: Brown Black Red / Gold: 5% tolerance

RTE : to keep door unlocked we need re-triggering of RTE input (Each trigger extends unlock timer)

DC : N.O. sensors are wired in parallel, N.C. sensors in series

Wiring : Up to 1,000' on 18-22 AWG 2-Cond. cable

READERS:

Wiring : Up to 500' Max from Reader to Panel on 18 AWG 6-Cond. Shielded Cable

Function	RBH	HID	AWID	Terminal
LED	Brown	Orange	Brown	GRN
Buzzer	Blue	Yellow	Yellow	BUZ
Data 0	Green	Green	Green	D0
Data 1	White	White	White	D1
Ground	Black	Black	Black	0V
Power	Red	Red	Red	12V

See reader manual for actual color codes!

EXITDR : This module allows reporting of direction on doors with readers installed on both sides, while using a single reader port on the controller (RBH reader wiring shown)

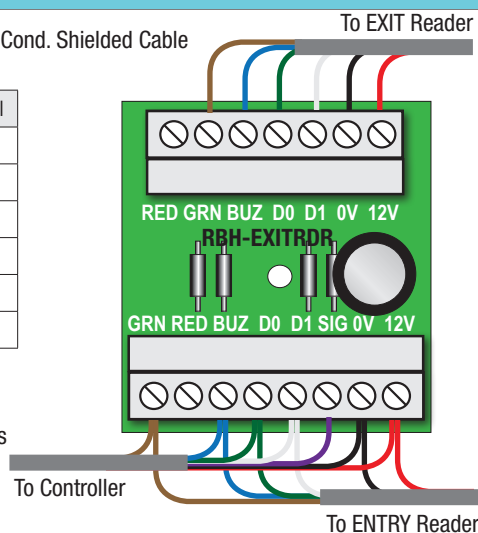

Reader LED	Status
Red	Locked
Green	Unlocked
Blinking	"High Security" mode

Reader Sounder	Event
Long Beep	Access Granted
Two short Beeps	Access Denied
Four Beeps	Mode Changed
Beeping	DHO Warning or PIN request
Continuously On	Door Forced or Door Held Open Alarm

NOTE : System Data

Complete database is stored on the Server PC, cards and settings are transferred to the panel during the download. Panel retains this data and operates independently, sending events to Server and receiving commands from it. It is not possible to "upload" hardware configuration or card database from the panel. **Please configure Integra32 Server's built in backup function to preserve your data in case of PC failure!**

Support

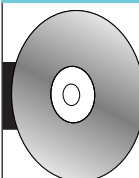

For Support in U.S. Call : **201-663-9070**

All software and hardware manuals are included on Integra32 software CD in "Documents" folder

Web site : www.rbh-access.com E-mail : support@rbh-access.com

Please read our manuals before contacting technical support! To access help (software manual) in Integra32 software hit F1 key!

DIP SWITCH SETTINGS : DIP-Switch: UP = ON / DOWN = OFF

Cycle power for DIP-switch changes to take effect!

Switch 8: Always OFF!

Switch	1	2	3	4	5	Switch	1	2	3	4	5	Switch	1	2	3	4	5	Switch	1	2	3	4	5	Switch	6	7
Panel 1	On					Panel 5	On		On			Panel 9	On			On		Panel 13	On		On	On		9.6 K		
Panel 2		On				Panel 6		On	On			Panel 10		On		On		Panel 14		On	On	On		19.2 K	On	
Panel 3	On	On				Panel 7	On	On	On			Panel 11	On	On		On		Panel 15	On	On	On	On		38.4 K		On
Panel 4			On			Panel 8				On		Panel 12			On	On		Panel 16					On	56 K	On	On

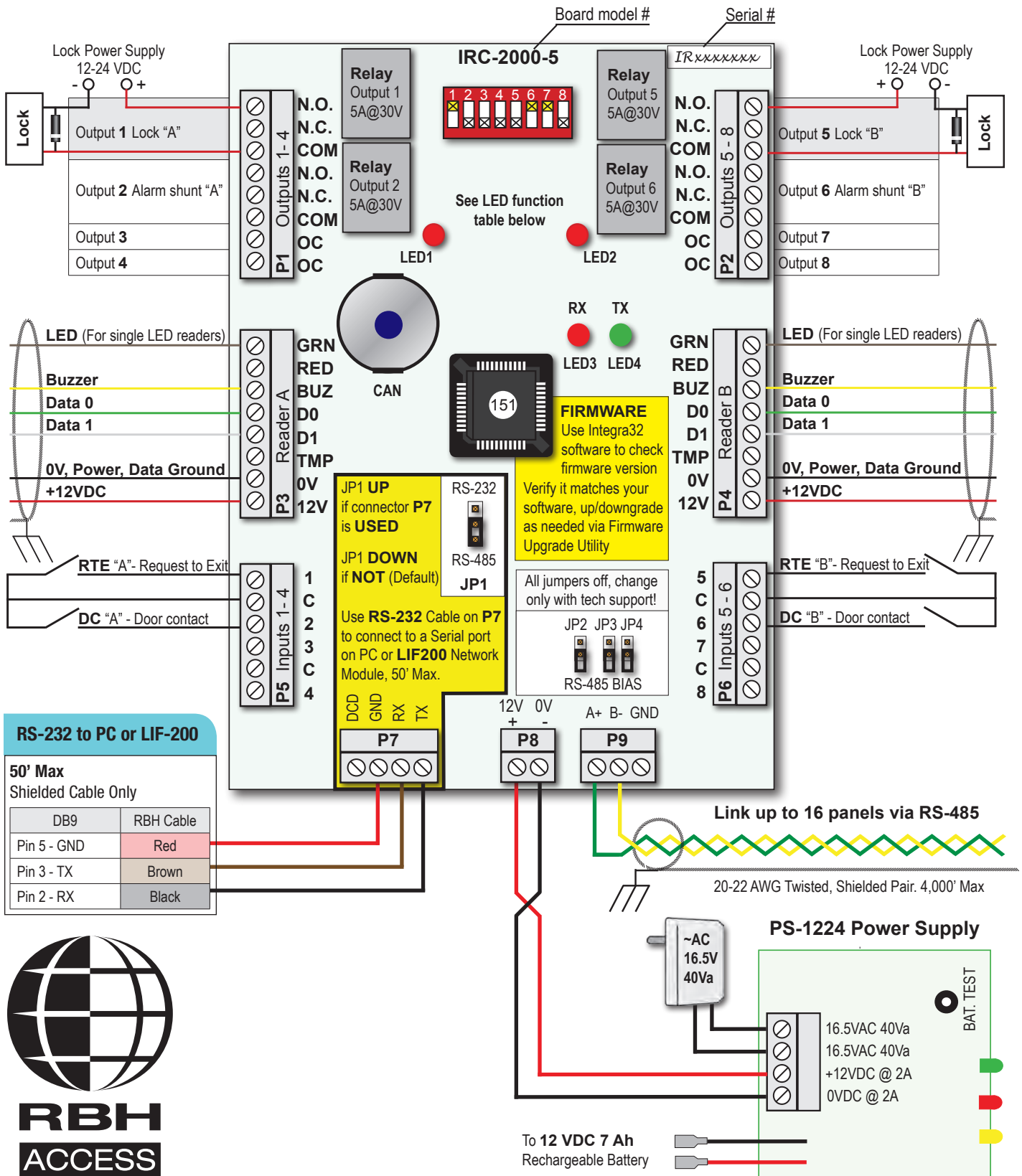

RS-232 to PC or LIF-200

50' Max Shielded Cable Only

DB9	RBH Cable
Pin 5 - GND	Red
Pin 3 - TX	Brown
Pin 2 - RX	Black



Panel LEDs

Panel LEDs	LED1 (Red)	LED2 (Red)	LED3 (Red)	LED4 (Green)
FUNCTION	Door forced	Host	Receive	Transmit
OFF	No	Power is off	Host not polling	Panel not responding
ON SOLID	Yes	Online	Malfunction	Malfunction
BLINKING	Card read	Offline	Receiving	Transmitting

Power Supply (PS-1224) LEDs

Press "BAT. TEST" button on PS-1224 for battery test, Yellow LED will go ON if test failed

LED	On	Off
Green LED	Power On	Power Off
Red LED	Shorted	OK
Yellow LED	Battery Fail	Battery OK